

Schunk – Carbon fiber-reinforced carbon (C/C)

International Technology Company

Schunk – industrial production to the highest standards

Schunk Materials is a division of the Schunk Group, a global technology company with an extensive range of services, both in materials technology and systems engineering.

In the area of high-temperature technology, we produce materials and components for use in the following areas:

- pressure sintering
- glass technology
- medical technology
- solar technology
- insulation technology
- crystal growing
- heat treatment

The Schunk Group is divided into several individual companies, which operate independently in different technology markets around the world. This structure ensures a high degree of flexibility and customer focus.

Global Player – active in 5 continents in 28 countries

As a global player, the Schunk Group is active in North and South America, Europe, Asia and Oceania, in a total of 28 countries, with more than 60 companies, and has a network of strategic alliances and cooperations, as well as connections to leading research institutes around the world.

In recent years, the Schunk Group has expanded significantly due to continuous innovation, development and diversification in future-oriented areas of technology.

We advise you – from the first idea to manufacturing

We accompany our clients during the entire planning and development process. In this way, many application and client-specific problems can be solved in early stages through the use of computer simulations. We support you both in the design and dimensioning of your component, and also in the choice of the most economic form of production.

Innovative technology

Schunk Kohlenstofftechnik GmbH specializes in the development of materials for the achievement of form, stability and resistance to extreme temperatures.

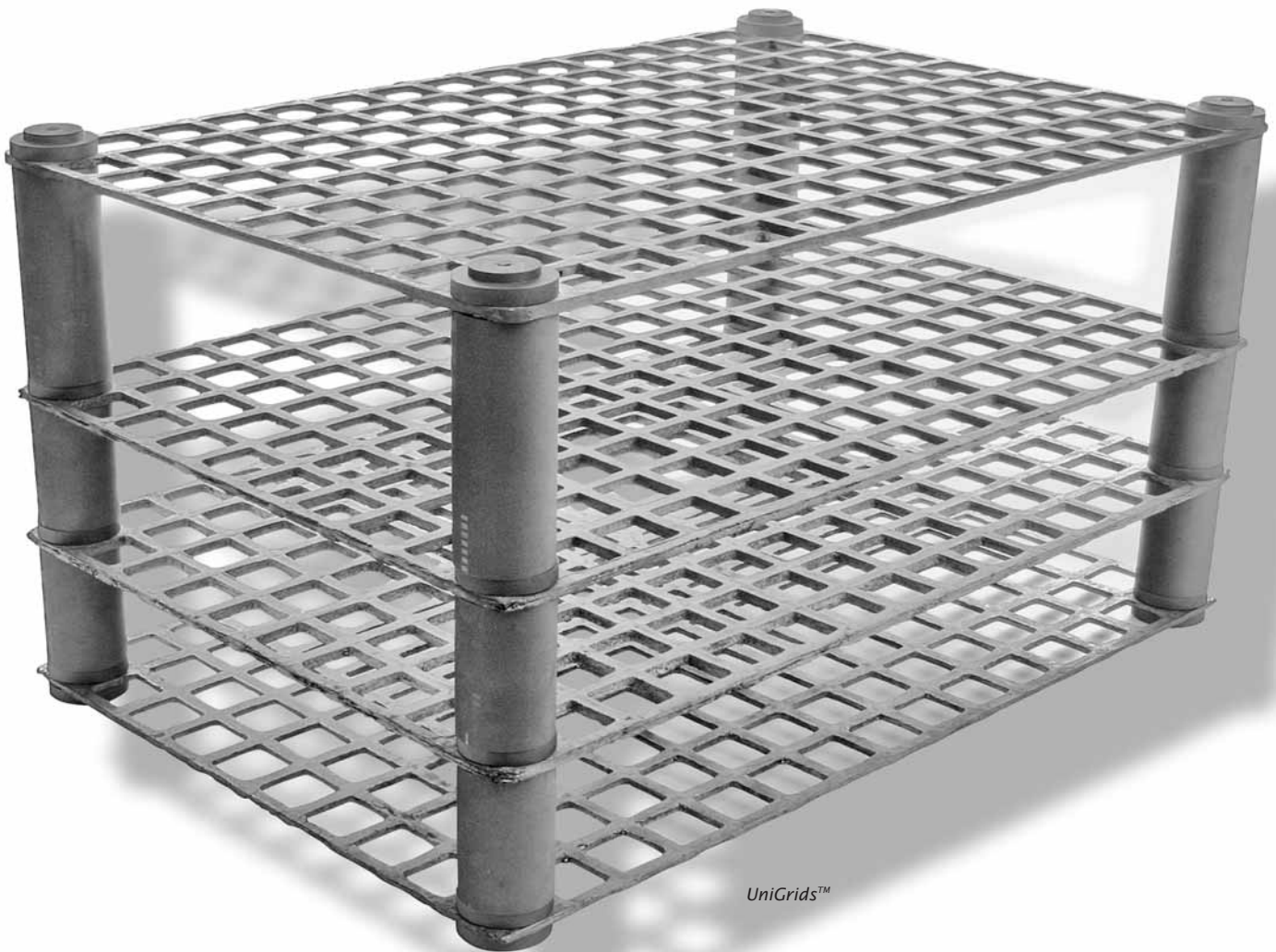

UniGrids™

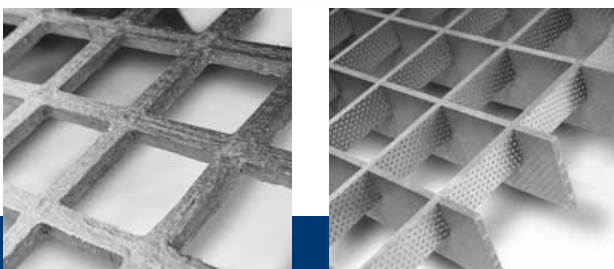

By varying material components, it is now possible to produce a fiber composite with specifically designed properties.

We can use this spectrum of possibilities to adapt carbon fiber-reinforced carbon (C/C) to meet the relevant requirements and desired component designs.

Your Process Partner for Fiber-reinforced Materials

Fiber-reinforced materials and their special properties

Technological progress and development require people to constantly combine different types of material. Combining materials in a composite structure allows for combinations of specific material properties which are otherwise impossible to achieve. The principle of the composite body is simple: at least two different components with specific properties are linked to form a new material. The use of fiber composites begins when conventional materials can no longer meet the requirements, due to high temperature or atmospheric stress.

Monolithic materials can be significantly improved with fiber reinforcement.

This creates materials with high, specific stiffness and strength at low densities. Due to the commercial availability of different types of fiber, there is a wide application range for fiber-reinforced composites. In fact today, for high temperature and high performance applications, carbon fiber-reinforced carbon (C/C) and carbon-fiber-reinforced-polymers (CFRP) dominate the field as the material of choice.

By varying production parameters, from the appropriate selection of components and processing, we can achieve a large range of C/C material qualities with different physical and mechanical properties. The variety of composite bodies is a result of:

- types of fiber
- fiber volume content
- fiber orientation
- layer construction
- infiltration media
- compression cycles
- final annealing temperature
- finishing

In international usage, carbon fiber-reinforced carbon is indicated with the following abbreviations:

- **CFC** (German)
- **C/C** (English)



Fixing elements

Production Process

Raw materials

Today's raw materials for C/C production may, in many respects, look very similar according to the appearance and the physical properties, whereby significant differences are achieved through appropriate preparation and thermal stages. Our extensive expertise in controlling the thermal processing chain guarantees our clients the highest process reliability and consistent quality, even with large batches.

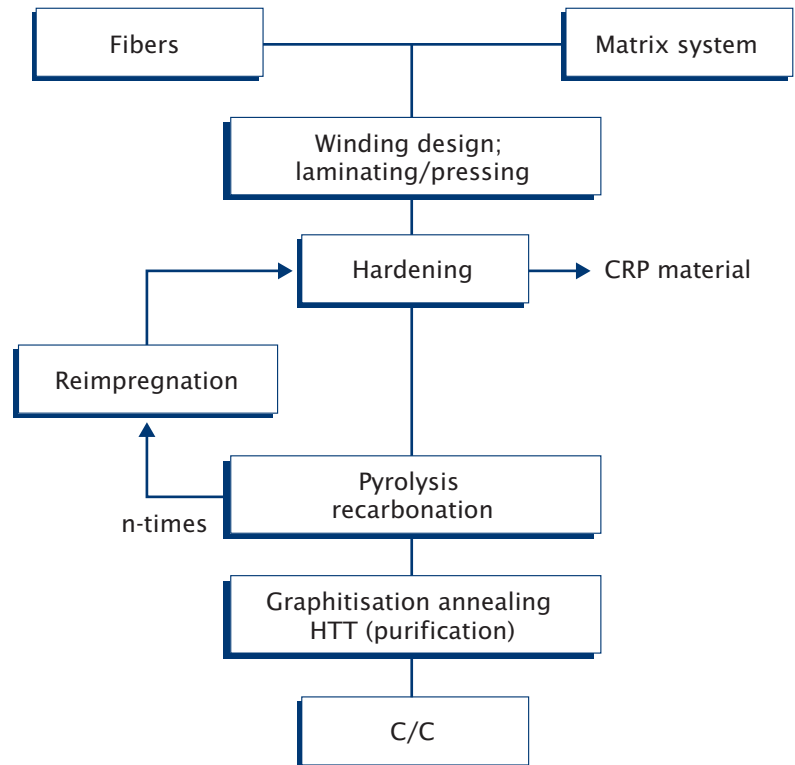

The C/C production process at Schunk Kohlenstofftechnik GmbH is based on a multi-level production process.

In accordance with the requirements profile, we use different technologies to fulfil the wishes of our clients.

In the first stage of production, the raw materials are combined. The molding process is carried out according to the required geometry.

The thermal processes include carbonization at >1,000°C and graphitization at >2,000°C.

The mechanical finishing enables accurate dimensional precision of the C/C products.

In addition to the overall process chain, we provide different finishing procedures, which expand the area of application and can further enhance specific properties.



Soft felt insulation pipe reinforced with C/C and graphite foils

Processing Route for C/C

Resin im
Capillary a
impregnati

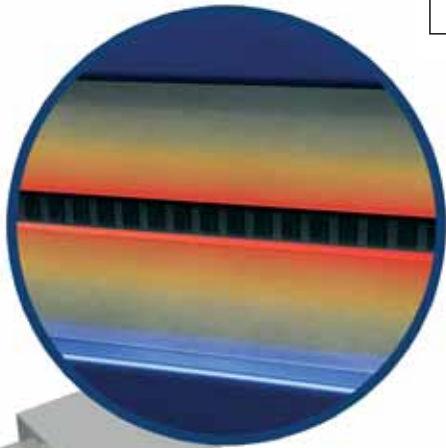
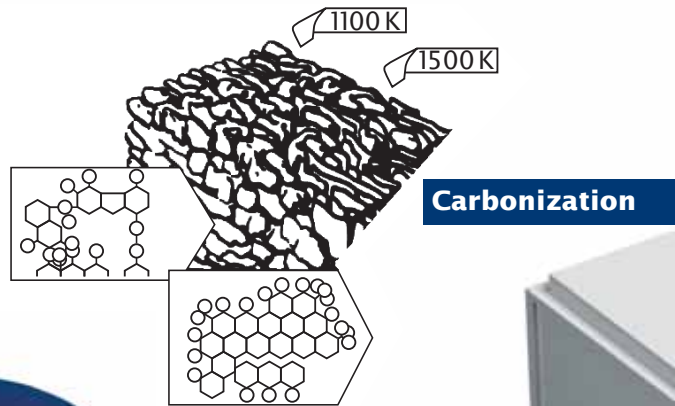

Press Technology

- Axial press
- Autoclave
- Drying cabinet for hardening

Preparation

Cutting, laying, stacking, aligning



Winding technology

- Turning lathe winding plant
- Cross winding
- Polar winding
- Radial winding

Impregnation

and pressure
ion

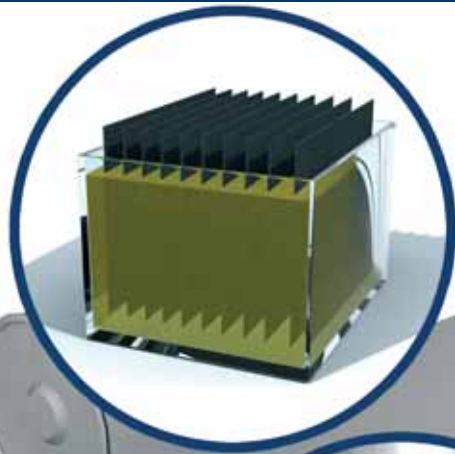
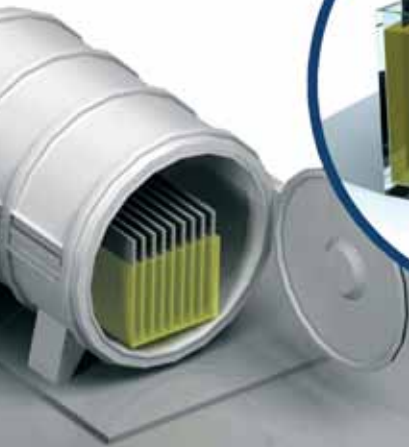

Finishing

- High-temperature cleaning
- CVD coatings
- CVI infiltration



Contouring

Wet saw

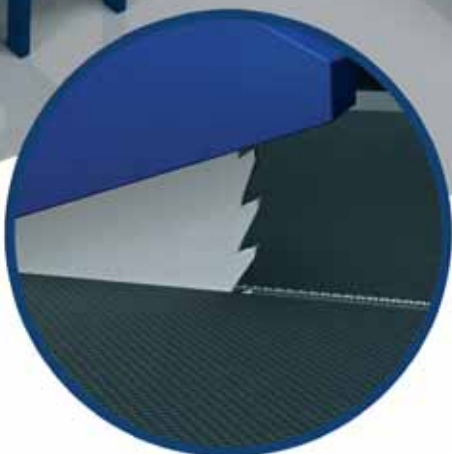

Graphitization

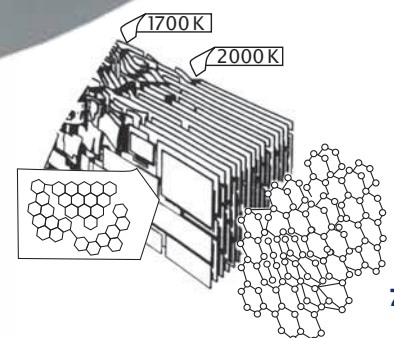

C/C – The High Temperature Material

Carbon fiber-reinforced carbon – C/C

Compared to conventional high-temperature materials, C/C materials are characterized by high performance across a wide spectrum of special properties. These properties enable the implementation of different solutions in the high-temperature range, where conventional materials fail.

C/C properties

- high damage tolerance, pseudoplastic fracture behaviour
- low density (1.3 – 1.8 g/cm³)
- low thermal expansion coefficient in fiber direction
- no brittleness at high temperatures over the entire lifespan
- high resistance to thermal shock
- no stress under thermo-cyclic load
- very good creep resistance at high temperatures
- good chemical stability
- adjustable electrical and thermal properties, dependent on fiber reinforcement and heat treatment
- over 350°C reaction with oxygen
- usable at temperatures of up to 2,800°C under vacuum or inert gas
- electroconductive
- anisotropy; flexural and tensile strength, electrical conductivity and thermal conductivity have different values in materials with C fibres orientated in the direction of the fibre than if they are perpendicular to the fibre or layer direction
- low thermal conductivity

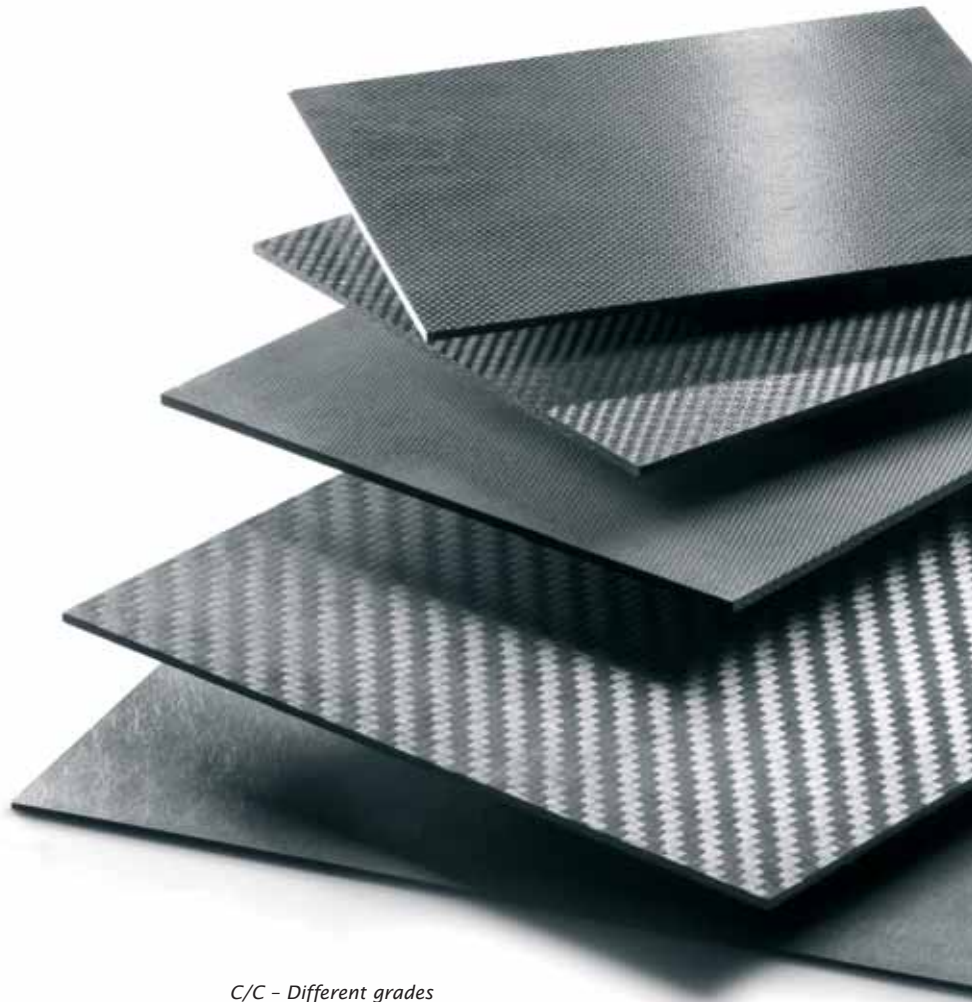

C/C – Different grades

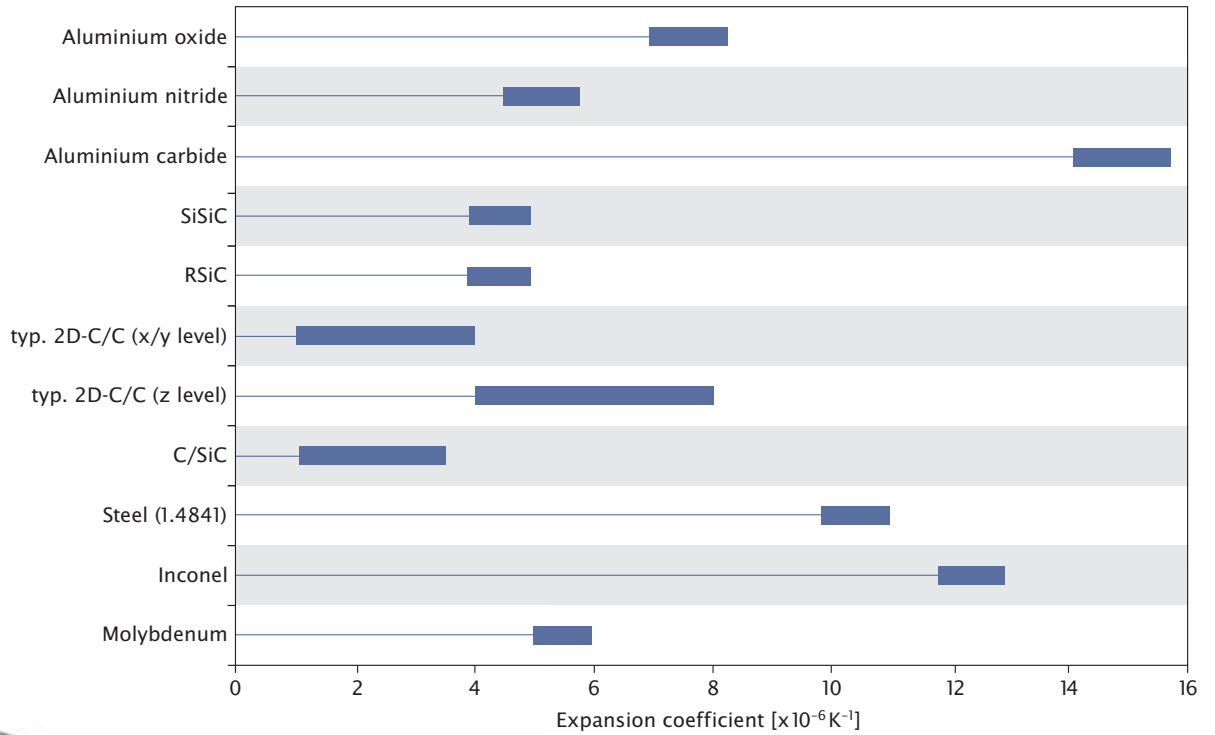

Properties of carbon fiber-reinforced materials compared with other construction materials.

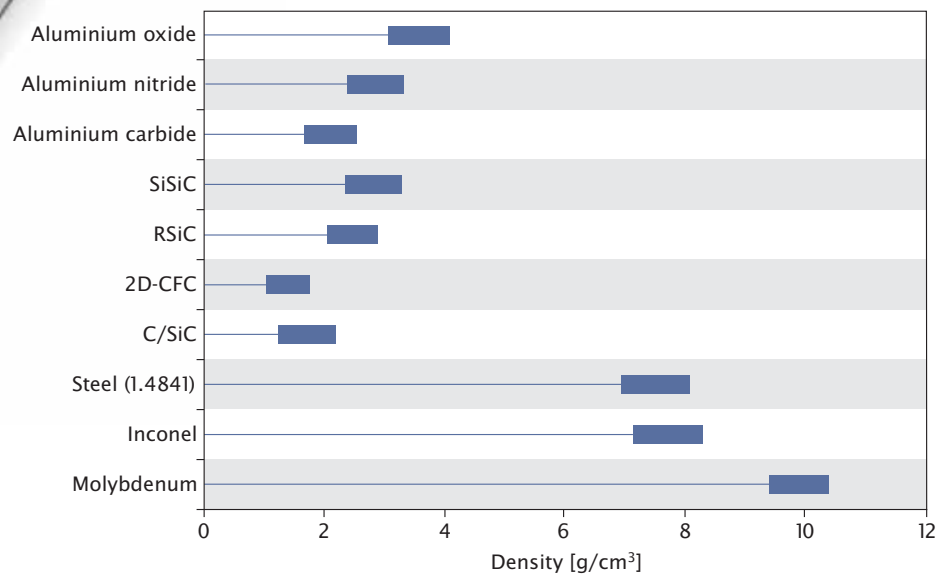

Specialist in Carbon Materials

Schunk material for structural applications

The mechanical properties of C/C materials are determined, alongside the fibres used, by the matrix and fibre architecture and end annealing temperature. In contrast to conventional ceramic and metallic materials, the strength and rigidity of carbon material increases around 15% with rising temperatures.

At high temperatures, C/C components are largely in a tension-free state.

The different material qualities are tailored composite structures for use under extreme conditions.

Schunk Kohlenstofftechnik GmbH offers a wide range of material solutions



C/C tray

Material-specific properties

Schunk Kohlenstofftechnik GmbH has many years of experience in finite element method of analysis (FEM). Tailored requirement profiles can therefore be analyzed and modelled.

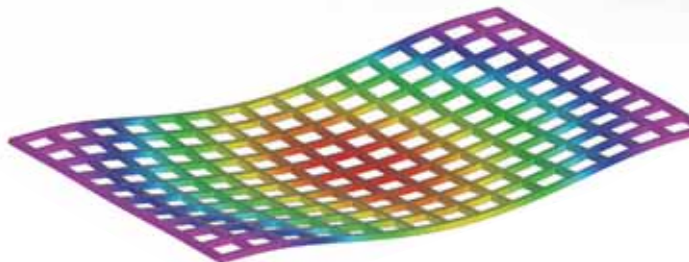

Schunk – C/C materials

Material properties*		CF 222/2	CF 225/2	CF 226/2	CF 227/2	CF 260
Type of reinforcement	Type	cloth	cloth	cloth	cloth	cloth
Annealing temperature	[°C]	2,000	2,000	2,000	2,000	2,000
Fiber volume fraction	[Vol.-%]	60	45	60	60	55
Bulk density	[g/cm ³]	1.35	1.4	1.35	1.4	1.35
Porosity	[%]	24	18	20	25	8
Flexural strength	[MPa]	140	80	100	100	80
Young's modulus	[GPa]	65	40	50	55	13
Breaking strain	[%]	0.2	0.3	0.18	0.2	0.8
Interlaminar shear strength	[MPa]	6	5	6	5	7
Coefficient of thermal expansion	[10 ⁻⁶ /K]	l to laminate level 0.8 └ to laminate level 7	l to laminate level 1.1 └ to laminate level 6	l to laminate level 1.1 └ to laminate level 7	l to laminate level 1 └ to laminate level 7	l to laminate level 3.5 └ to laminate level 4.5
Specific electrical resistance	[μ ² /m]	at room temperature 25 at 2,000 °C 12.5	at room temperature 40 at 2,000 °C 15	at room temperature 28 at 2,000 °C 14	at room temperature 28 at 2,000 °C 15	at room temperature 50 at 2,000 °C 24
Thermal conductivity	[W/mK]	l to laminate level 20 └ to laminate level 4	l to laminate level 13 └ to laminate level 3	l to laminate level 20 └ to laminate level 2	l to laminate level 20 └ to laminate level 2	l to laminate level 9 └ to laminate level 5
Fracture behaviour	Type	pseudoplastic	pseudoplastic	pseudoplastic	pseudoplastic	pseudoplastic
Ash content	[ppm]	> 300	> 300	> 300	> 300	> 300

* The given values are not authoritative, but are typical values from our experience. Material and production-specific distribution is to be taken into account.

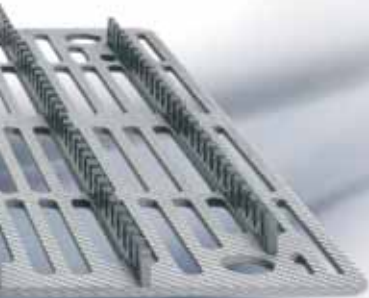

We are also able to adapt our standard materials by modification with pyrolytic carbon (PyC). We are happy to provide you further details about this if needed.

Schunk– C/C materials

Material properties*		CF 222	CF 225	CF 226	CF227
Type of reinforcement	Type	cloth	cloth	cloth	cloth
Annealing temperature	[°C]	2,000	2,000	2,000	2,000
Fiber volume fraction	[Vol.-%]	60	45	60	60
Bulk density	[g/cm ³]	1.55	1.5	1.5	1.55
Porosity	[%]	8	9	8	8
Flexural strength	[MPa]	200	110	120	170
Young's modulus	[GPa]	80	50	60	80
Breaking strain	[%]	0.25	0.25	0.23	0.3
Interlaminar shear strength	[MPa]	8	8	8	9
Coefficient of thermal expansion	[10 ⁻⁶ /K]	l to laminate lvl. 0.8 └ to laminate lvl. 7	l to laminate lvl. 1 └ to laminate lvl. 6.5	l to laminate lvl. 0.8 └ to laminate lvl. 7.3	l to laminate lvl. 1.1 └ to laminate lvl. 7.3
Specific electrical resistance	[μ ² /m]	at room temperature 22 at 2,000 °C 12	at room temperature 30 at 2,000 °C 17	at room temperature 25 at 2,000 °C 12	at room temperature 22 at 2,000 °C 12
Thermal conductivity	[W/mK]	l to laminate lvl. 40 └ to laminate lvl. 10	l to laminate lvl. 30 └ to laminate lvl. 10	l to laminate lvl. 40 └ to laminate lvl. 5	l to laminate lvl. 40 └ to laminate lvl. 5
Fracture behaviour	Type	pseudoplastic	pseudoplastic	pseudoplastic	pseudoplastic
Ash content	[ppm]	> 300	> 300	> 300	> 300

Schunk – Filament Winding

Schunk – Filament winding

In addition to plate geometries, Schunk Kohlenstofftechnik GmbH can also produce rotationally symmetric components.

Our C/C wound components are used primarily in the solar and semiconductor industry, where we are successfully positioned for high mechanical, and the highest purity requirements.

After final dimension processing, our C/C wound components are subject to further finishing stages appropriate for their intended use.

C/C crucible



Qualitative assessment of our usual processing methods

	Prepreg technology	Winding technology
Geometry	complex	rotation-like
Pores/Inserts	possible	possible
Stiffeners	possible	difficult
Undercuts	possible	not possible
Surfaces	good	good
Fiber architecture	arbitrary	arbitrary
Typical fiber volume content	65%	60%
Mechanical properties	very good	very good
Quality	very good	very good
Reproducibility	very good	very good

Our philosophy of component production and finishing is reflected in our performance. We have many years of experience in all areas of materials development and would like to share this with you.



C/C – Fracture Behaviour



C/C heater

Failure behaviour

In contrast to conventional ceramic materials, the C/C composite structure has the advantage of quasi-ductile or pseudoplastic behaviour, vs. a sudden total failure during stress on the body.

This fracture behaviour is not the same as the plastic deformation that can be seen with metallic materials. However, it still tolerates a greater degree of stress without causing complete failure of the component, compared to conventional ceramics.

Under the applied load, a few strands of fiber first crack, causing a fiber pull-out effect, a leading indicator of failure. Component failure occurs only after repeated cyclic loading, where the composite body has high residual strength.

The composite structure of a C/C component shows no brittle fracture with overuse, making it possible to use nails in this type of material. This is made possible both by the pseudo plasticity and the open porosity.

Schematic representation of the fracture curve in tensile and bending load

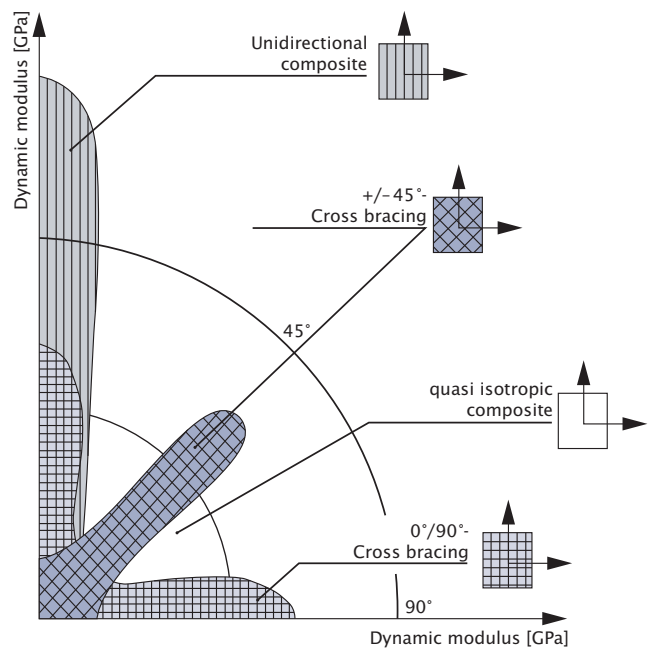
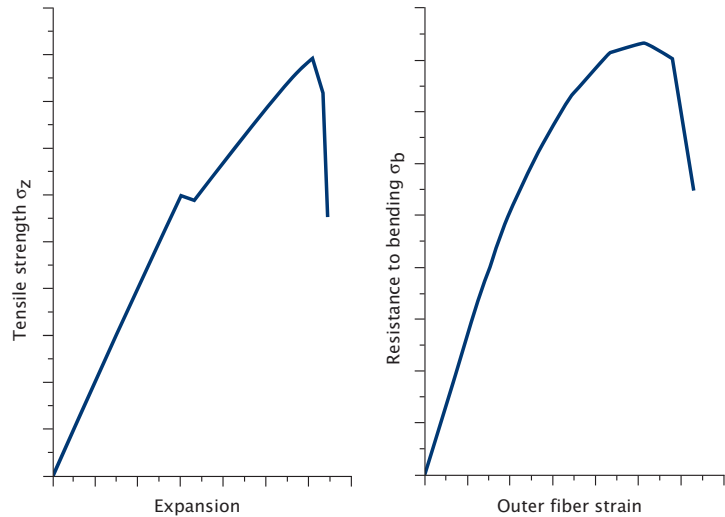

Schematical diagram of hysteresis during cyclical stress test

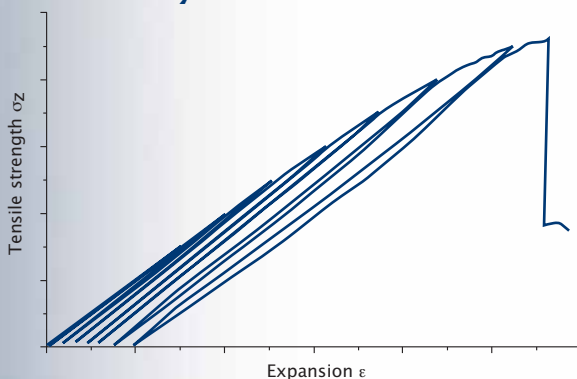

Schematical diagram of the fatigue strength of C/C

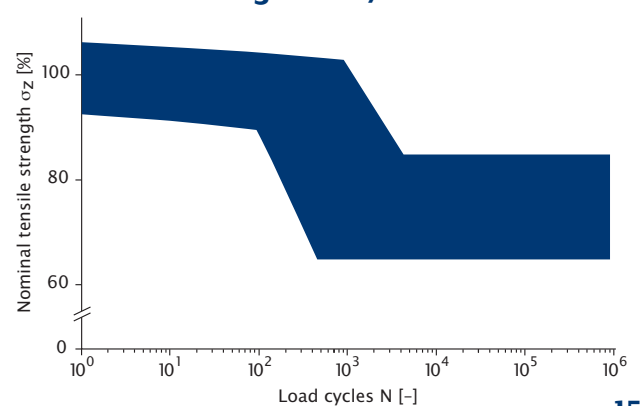

C/C – Physical Properties

Thermal shock resistance

The superior thermal shock resistance, compared to conventional ceramic and metallic materials,

makes C/C a unique high-temperature material. Due to the micro-structure, thermal stresses are

reduced. C/C composite bodies, therefore, have high thermal shock resistance.

Specific electrical resistance

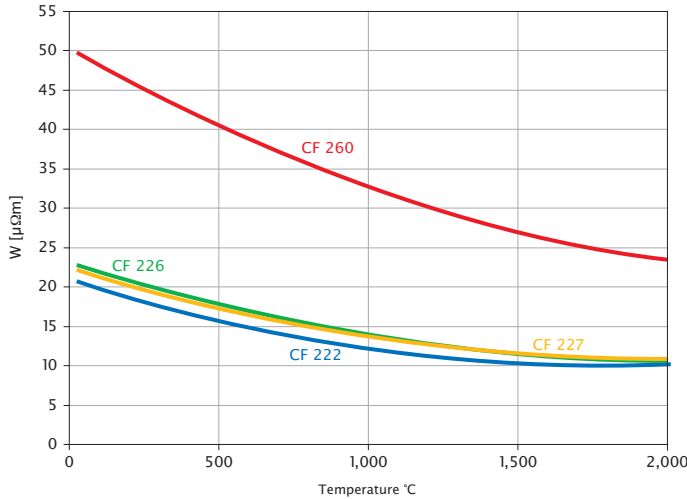

Expansion coefficient X axis

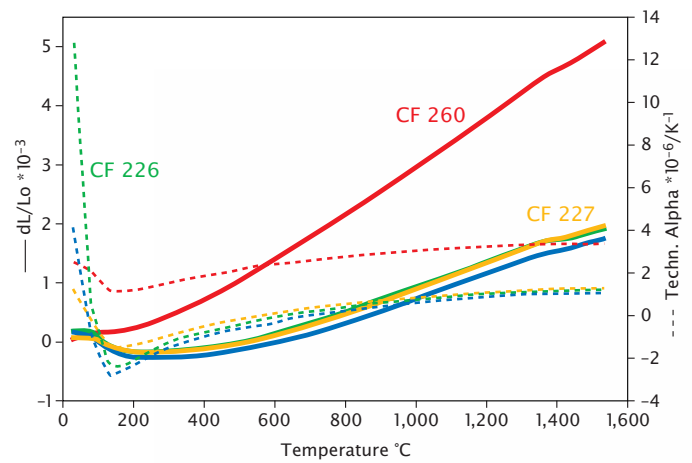

Specific heat

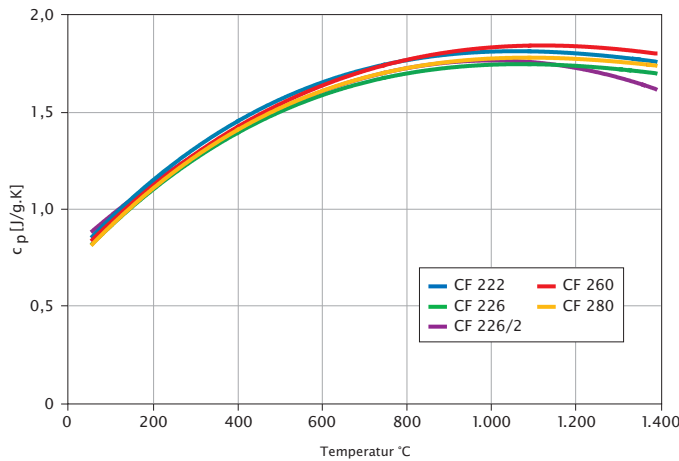

Expansion coefficient Y axis

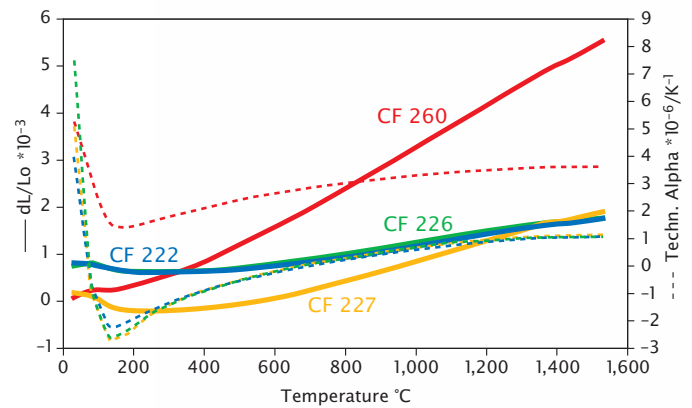

Thermal conductivity Z axis

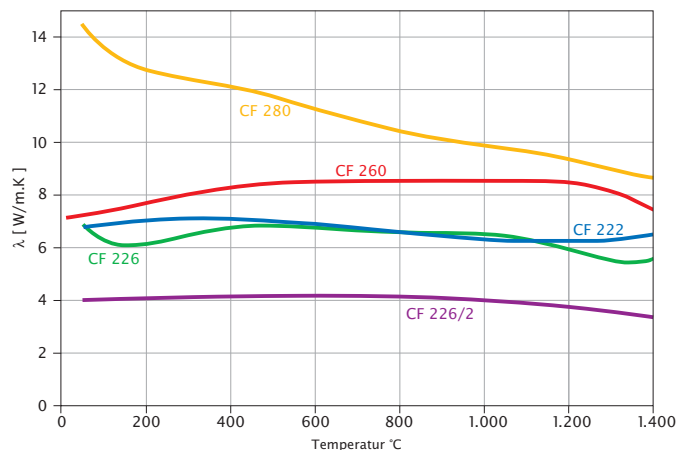

Expansion coefficient Z axis

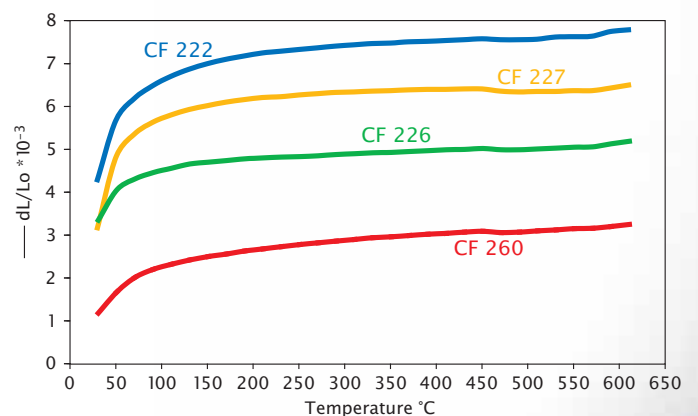

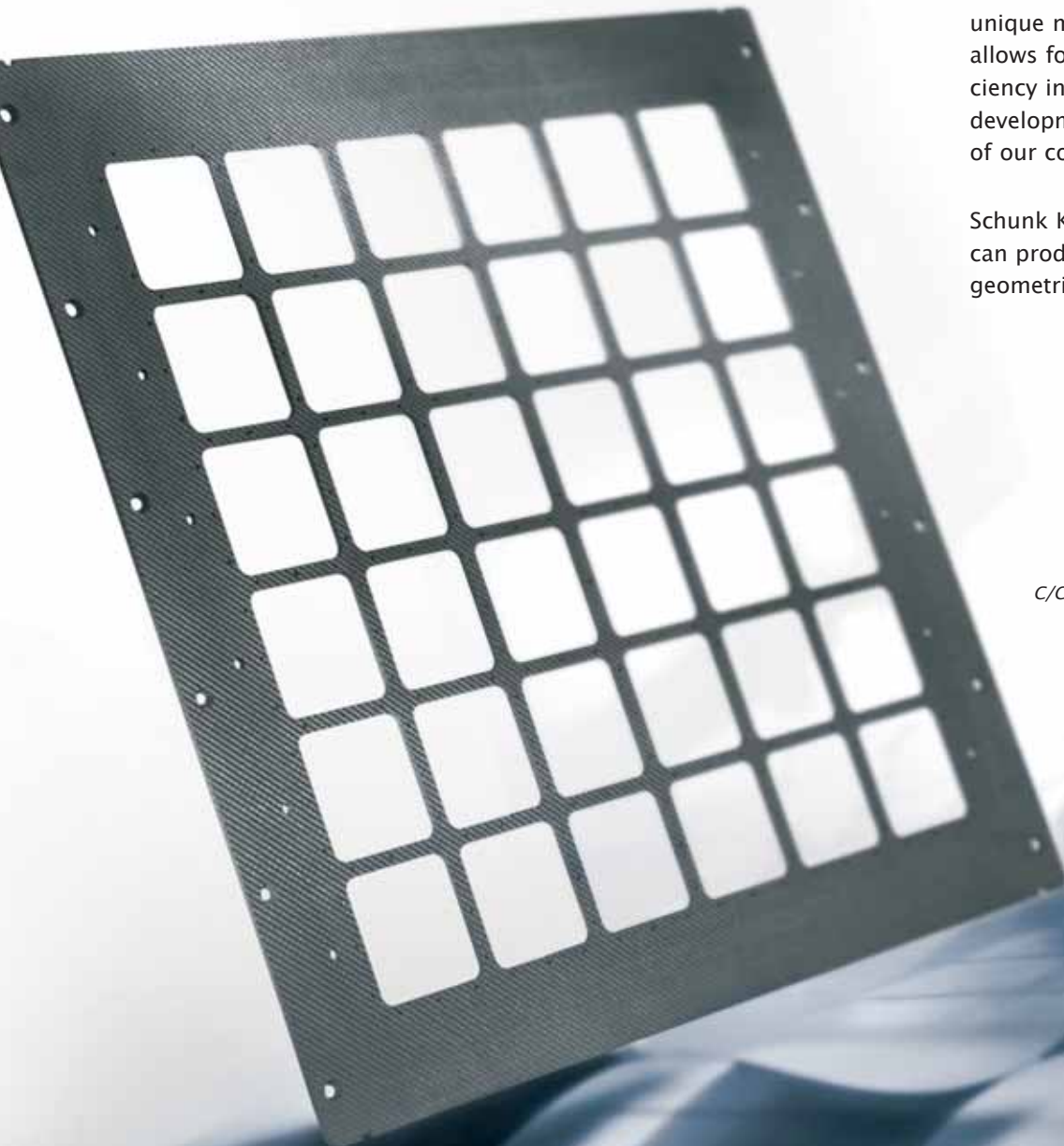

Schunk – Wafer carrier and tray systems

C/C carrier systems by Schunk Kohlenstofftechnik GmbH are used successfully in today's mainstream high-temperature systems in the solar industry, semiconductor technology and hardening technology.

Our technological edge and constant development at all levels of C/C production enable us to meet tomorrow's needs today. Our unique manufacturing process allows for the highest level of efficiency in the production, further development and quality assurance of our components.

Schunk Kohlenstofftechnik GmbH can produce single-piece plate geometries of up to 6 m².

C/C carrier

C/C – Chemical Stability



Insulation tube

Oxidation behaviour

In atmospheres containing oxygen, C/C composites are attacked by oxidation in the same way as other types of carbon. Above 350°C, oxidation will cause mechanical weakening of the material by damaging the carbon matrix.

Accordingly, the material may only be used in an atmosphere containing oxygen if appropriate protective measures are implemented.

With such measures, the combustion speed is reduced considerably, and the life span is prolonged.

Typical impurities

Further reactions that could arise under certain conditions are methanation and carbide formation.

Element concentration*	unpurified	purified
Cu	0.2	< 0.04
Cr	0.6	< 0.04
Mn	0.3	< 0.02
Zr	0.5	< 0.04
Co	0.2	< 0.02
Ni	0.6	< 0.04
V	0.4	< 0.04
Mo	0.5	< 0.04
Mg	0.7	< 0.04
Ti	7	< 0.04
W	1	< 0.04
Al	3	< 0.05
Fe	15	< 0.07
Ca	10	< 0.07
Ash content	>300 ppm	< 10 ppm

* The given values are not authoritative, but are typical values from our experience. Material and production-specific distribution is to be taken into account.

Chemical stability

Atmosphere	Reaction starts at	Reaction
Air	350°C	Oxidation
Steam	700 – 750°C	Oxidation
CO ₂	800 – 900°C	Oxidation
H ₂	1,000 – 1,200°C	Methanation
N ₂	2,000 – 2,500°C	Cyanide formation
Cl ₂	2,500°C	Vaporisation
Ar	3,000°C	Vaporisation
Vacuum	2,200°C	Vaporisation

Chemical purity

In principle, the composite structure C/C material contains only the element carbon.

Nevertheless, there are a number of impurities resulting from the manufacturing process.

These are typically in the range of 300 ppm. As a general rule, the higher the temperature treatment, the fewer the impurities. Impurities can be reduced to <10 ppm using special high-temperature purification processes.

- Schunk Kohlenstofftechnik GmbH
Germany/Heuchelheim
Telephone: +49 (641) 60 80
- Schunk Bahn- und Industrietechnik GmbH
Germany/Wettenberg
Telephone: +49 (641) 80 30
- Schunk Bahn- und Industrietechnik GmbH
Austria/Bergheim
Telephone: +43 (662) 45 92 00
- Schunk Ingenieurkeramik GmbH
Germany/Willich
Telephone: +49 (2154) 49 70
- Gerhard Präzisionspresstechnik GmbH
Germany/Obernzenz
Telephone: +49 (9844) 9 71 10
- Schunk Nordiska AB
Sweden/Lenhovda
Telephone: +46 (474) 2 95 00
- Schunk UK Ltd.
Great Britain/Pudsey
Telephone: +44 (113) 2 56 72 38
- Schunk Benelux B.V.
Netherlands/Rotterdam
Telephone: +31 (10) 4 14 47 66
- XYCARB Ceramics B.V.
Netherlands/Helmond
Telephone: +31 (492) 57 87 87
- Xycarb Ceramics Inc.
USA/Georgetown
Telephone: +1 (512) 8 63 00 33
- XYCARB Ceramics (Singapore) Pte. Ltd.
Singapore/Singapore
Telephone: +65 (636) 06 72
- Schunk Electrographite S. A. S.
France/Nanterre Cedex
Telephone: +33 (141) 19 52 52
- Schunk AG
Switzerland/Adliswil
Telephone: +41 (44) 7 16 46 46
- Schunk Wien Gesellschaft m.b.H.
Austria/Vienna
Telephone: +43 (1) 61 66 80 70
- Hoffmann & Co. Elektrokohle AG
Austria/Bad Goisern
Telephone: +43 (6135) 40 00
- Schunk Italia S.r.l.
Italy/Magenta
Telephone: +39 (02) 9 72 19 01
- Schunk Ibérica S. A.
Spain/Pinto
Telephone: +34 (91) 6 91 25 11
- Schunk Portugal Lda.
Portugal/Marinha Grande
Telephone: +351 (244) 57 24 80
- SIRMA Elektrik Kömürleri SAN TIC AS
Turkey/Istanbul
Telephone: +90 (212) 2 70 35 65
- Schunk Praha s.r.o.
Czech Republic/Plzen
Telephone: +420 (377) 45 41 21
- Schunk Carbon Technology SRL
Rumania/Bucharest
Telephone: +40 (21) 3 37 28 59
- Hoffmann Carbon Kft.
Hungary/Csesztreg
Telephone: +36 (92) 50 09 00
- Schunk Bahntechnik Polska Sp.z.o.o.
Poland/Warszawa
Telephone: +48 (22) 8 24 04 11
- OOO NPP "Soyuzkarbon"
Russia/Krasnodar
Telephone: +7 (861) 2 00 62 36
- Schunk Graphite Technology LLC
USA/Menomonee Falls
Telephone: +1 (262) 2 53 87 20
- Schunk Electro Carbón, S. A. de C.V.
Mexico/Ocoyoacac
Telephone: +52 (728) 2 82 78 90
- Schunk (Aust) Pty. Ltd.
Australia/Rowville
Telephone: +61 (3) 97 53 35 88
- Schunk do Brasil Ltda.
Brazil/São Paulo
Telephone: +55 (11) 46 13 32 02
- Schunk Metal & Carbon (I) Pvt.Ltd.
India/Bangalore
Telephone: +91 (80) 28 51 85 07
- Pichit Industrial Works Co., Ltd.
Thailand/Bangkok
Telephone: +66 (56) 63 34 27
- Schunk General Carbon
(Guangzhou) Co., Ltd.
China/Panyu
Telephone: +86 (20) 34 63 48 88
- Schunk General Carbon Ltd.
China/Hong Kong
Telephone: +852 (2) 4 08 66 88
- Jiangsu Seung Lim Electric Co. Ltd.
China/Jiangsu
Telephone: +86 (511) 8 42 08 97
- Seung Lim Carbon Metal Co., Ltd.
South Korea/Ansan-City
Telephone: +82 (31) 4 91 27 22

Schunk Kohlenstofftechnik GmbH

Rodheimer Strasse 59
35452 Heuchelheim
Germany

Telephone: +49 (0) 641 608-0
Telefax: +49 (0) 641 608-1223

infobox@schunk-group.com
www.schunk-group.com